

A	B	C		D
1	L112-0005	1204	660	7/7
2	L112-0006	1204	660	7/7
3	L112-0007	1204	440	6/7
4	L112-1009	2250	551	1/7
5	L112-1010	2250	580	2/7
6	L112-1011	2250	535	1/7
7	L112-3003	1176	535	3/7
8	L112-3004	1176	535	3/7
9	L112-3005	1176	480	4/7
10	L112-4005	1176	51	3/7
11	L112-4006	1176	51	3/7
12	L112-9302	2178	1185	2/7
13	dr-1171	1171	30	3/7
14	EG-sp_2200	2200	-	5/7

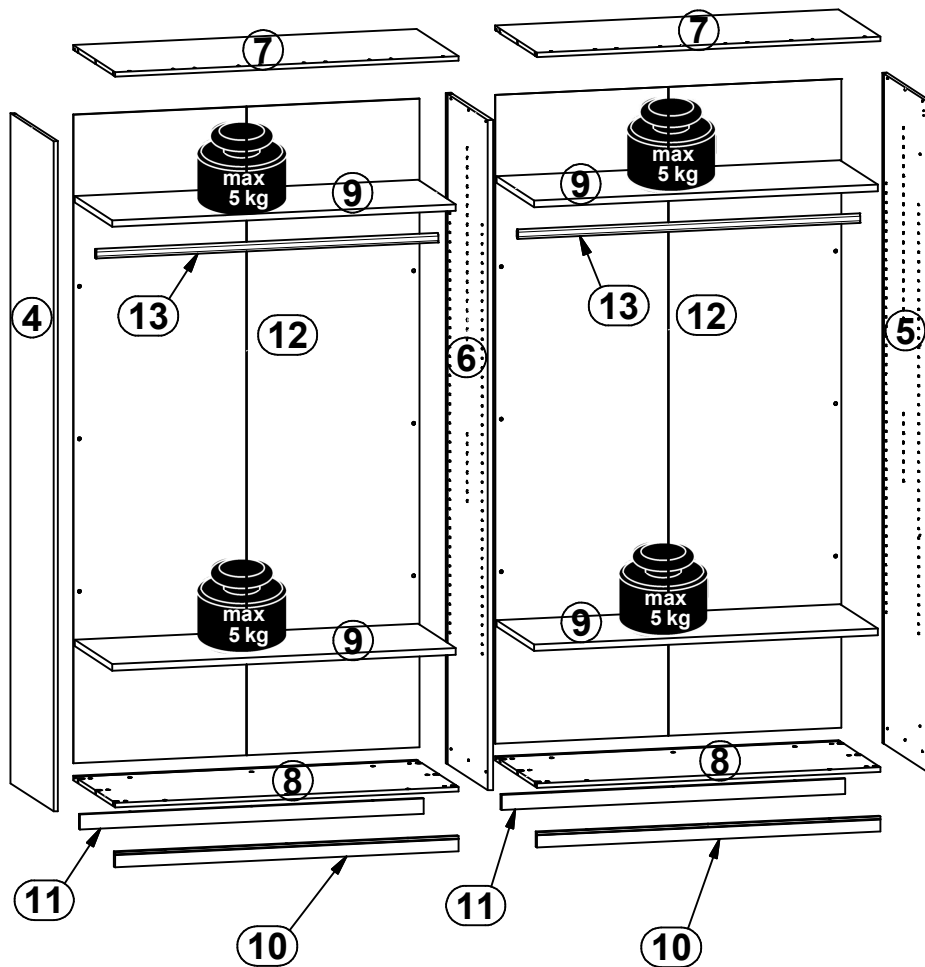

2x

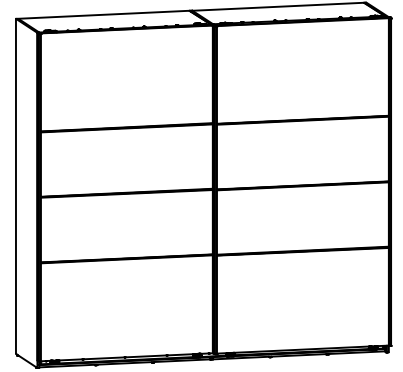
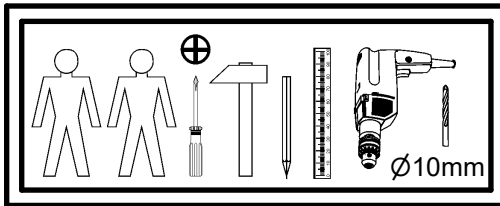
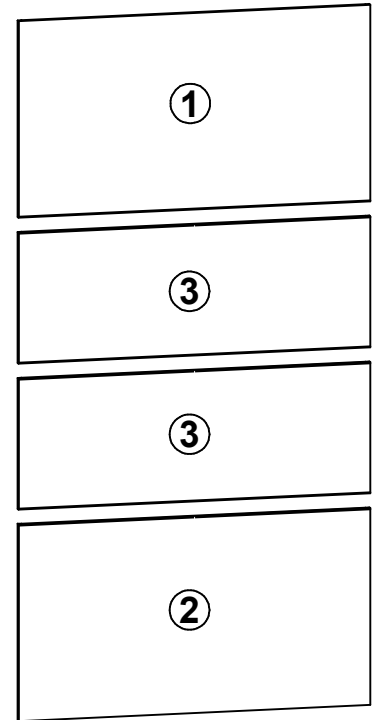

12x d20	16x d28	12x e1	24x e5	12x e50	16x e51	10x j84	10x j106	10x j140
2x j196	14x k1	20x l2	6x l63	12x n148	4x n158	4x p1	13x p25	96x p93
24x r37	24x r59	12x s1	14x s59	1x w249/2	1x w250/2	1x w118/7	3x w136/3	1x n238
1x n239	1x n240	1x n241	2x f69	2x f70	1x f71	1x f72	1x f73	1x f74
2x f75	2x f76	4x f77	2x s113	2x n14/2	4x p38	2x f35	2x p17	

1 §2

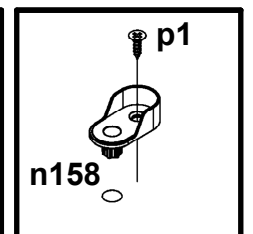
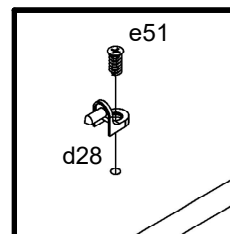
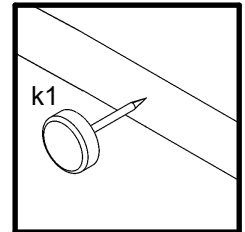
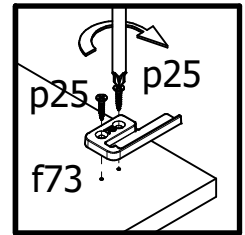
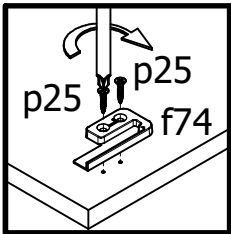
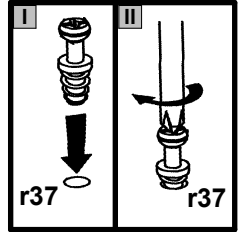
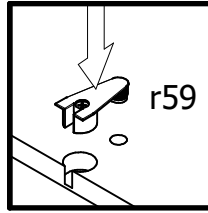
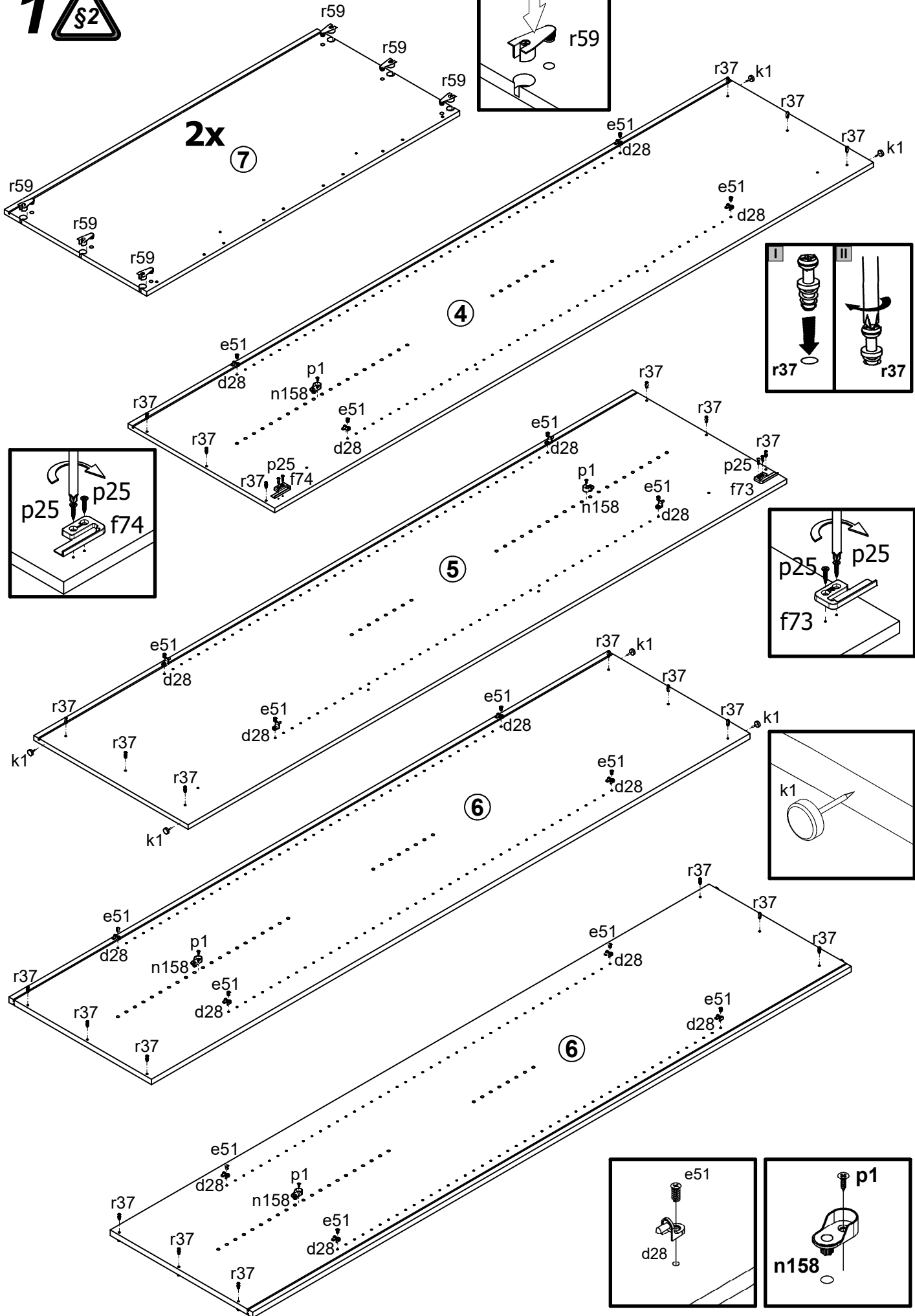

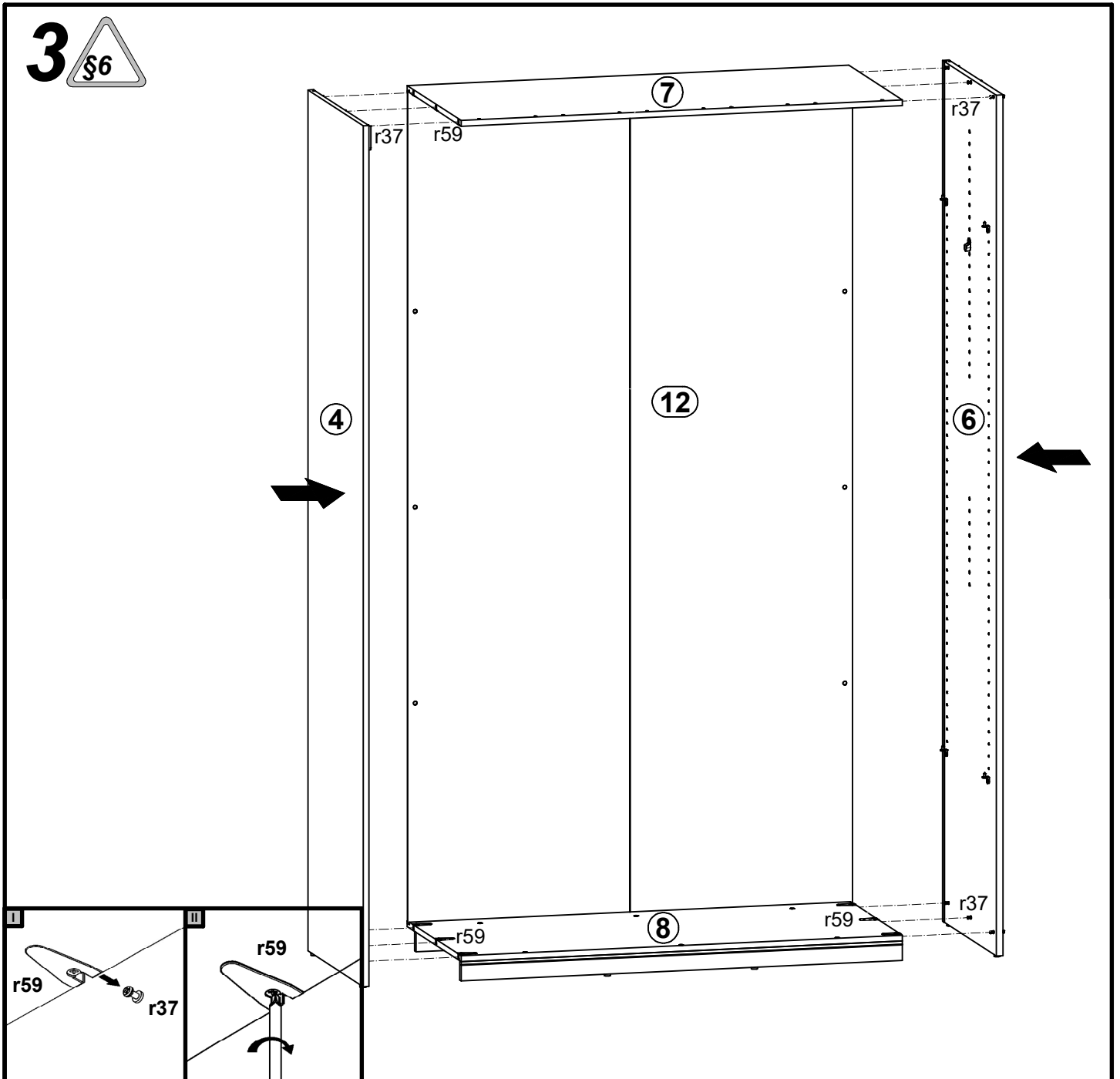
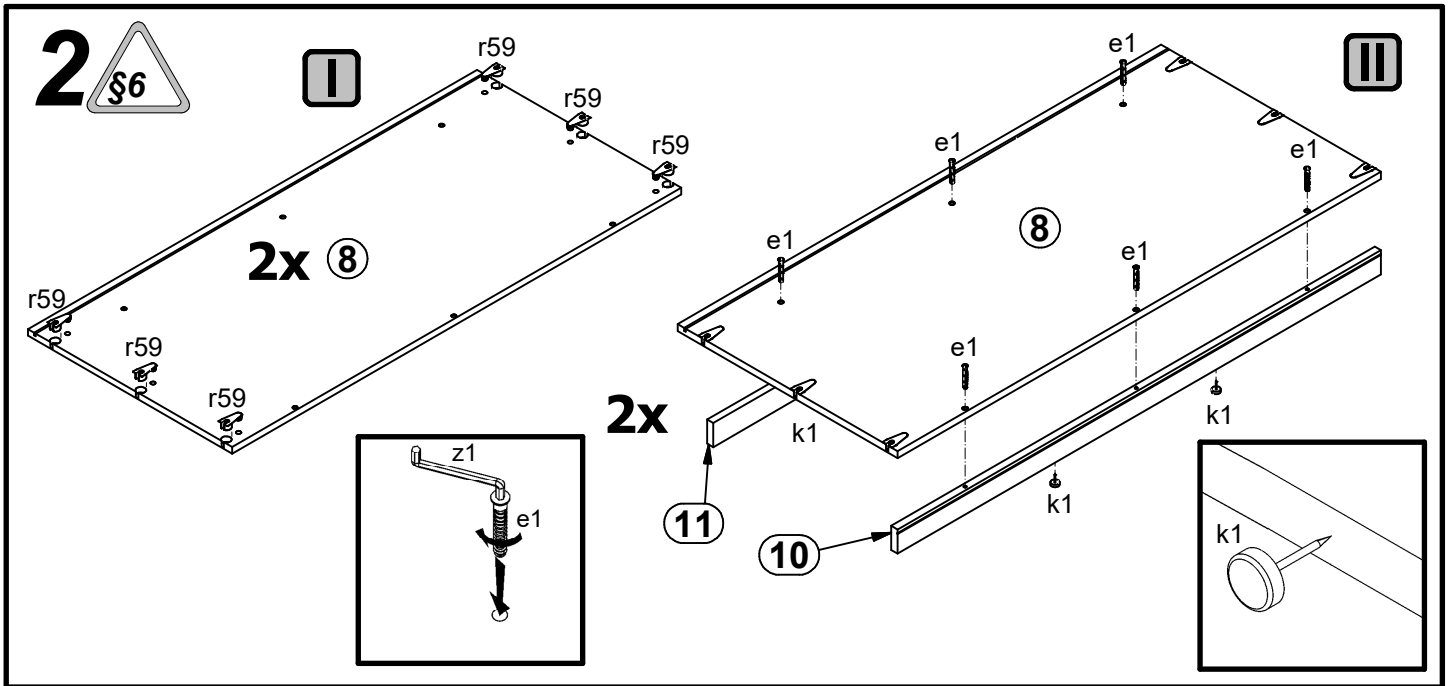

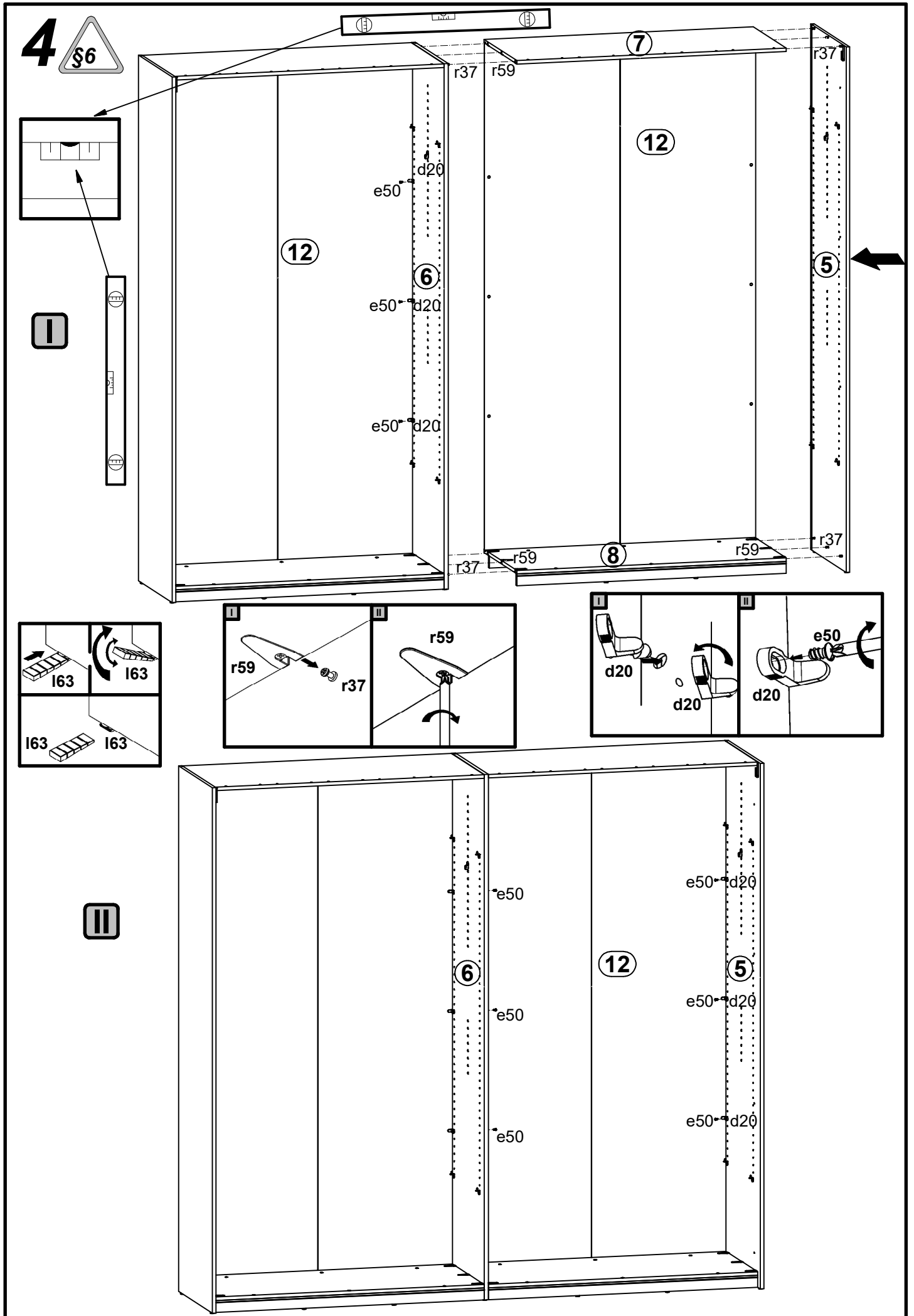

5  §6

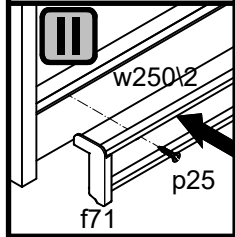
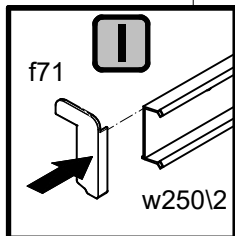
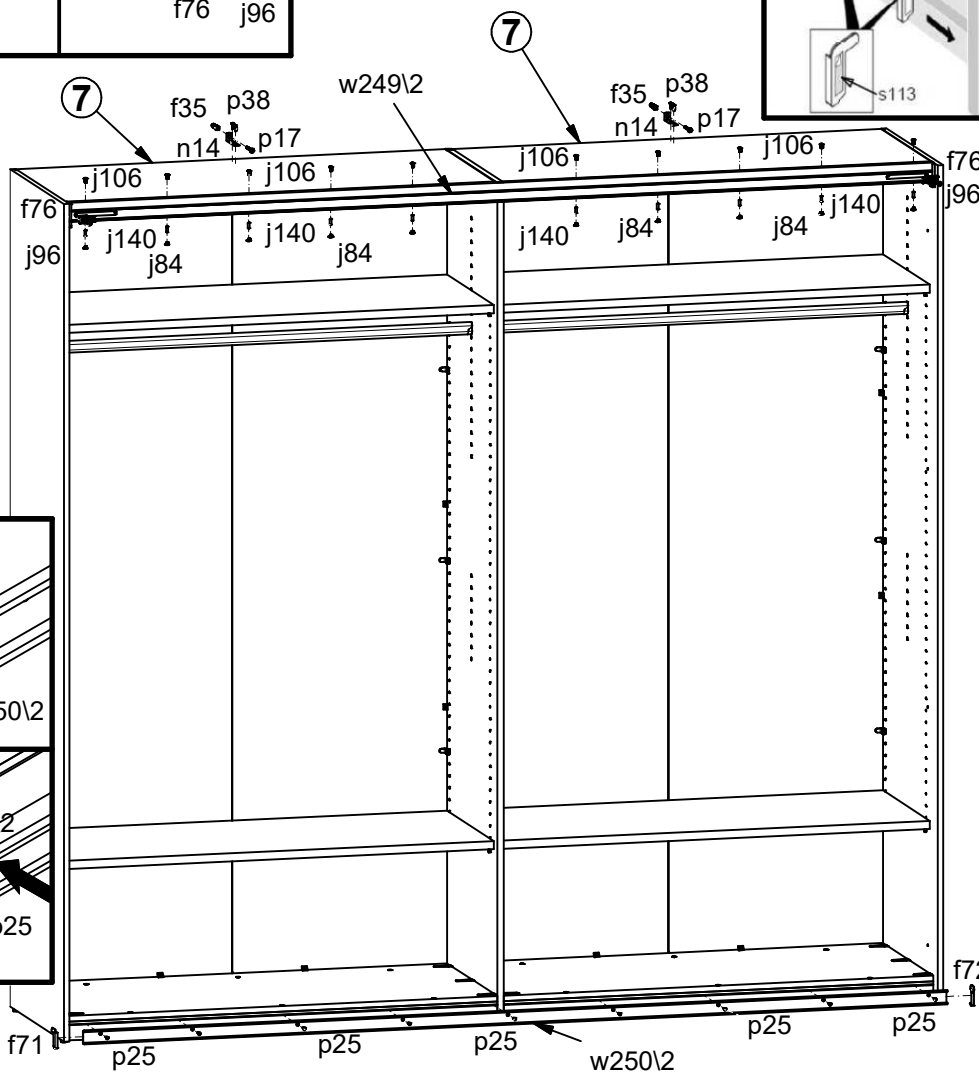
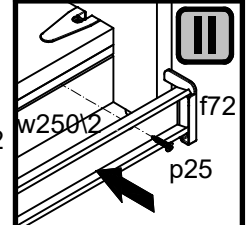
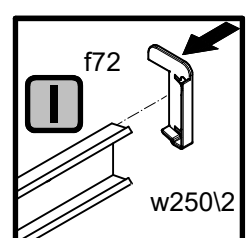
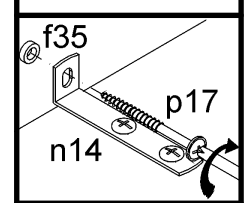
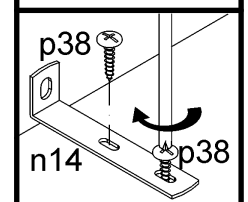
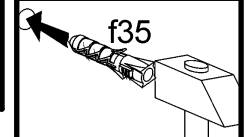
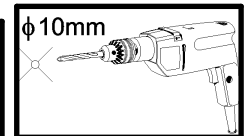
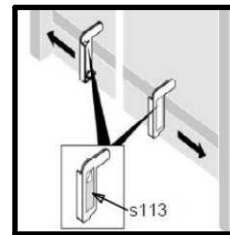
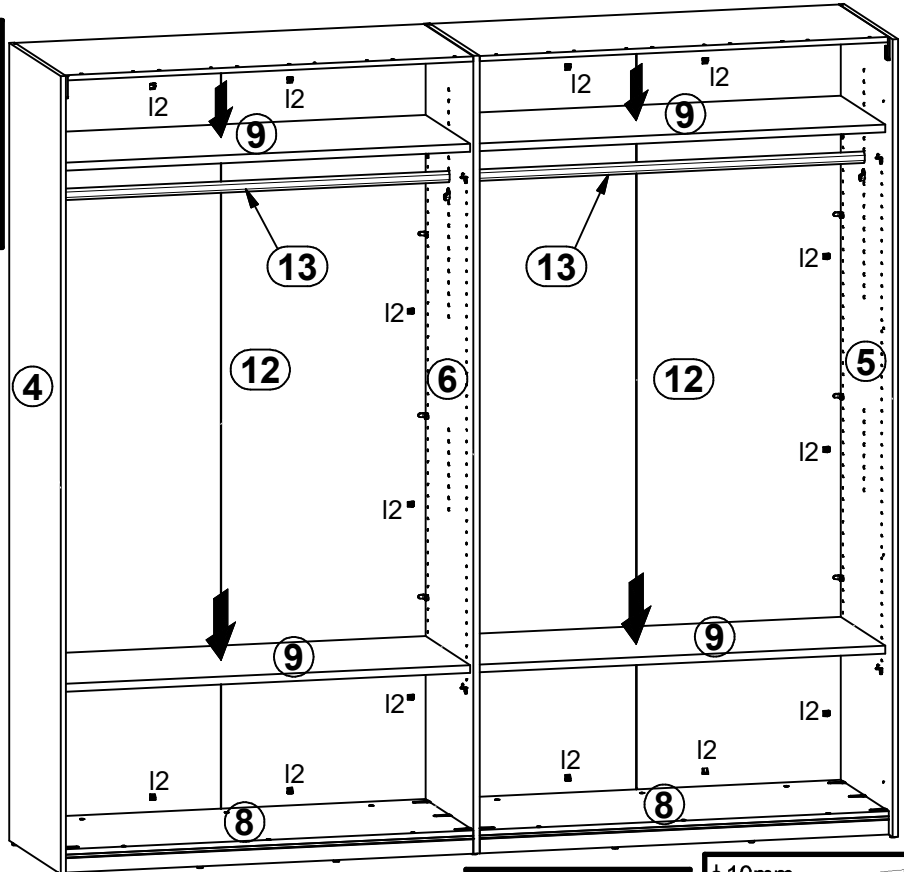
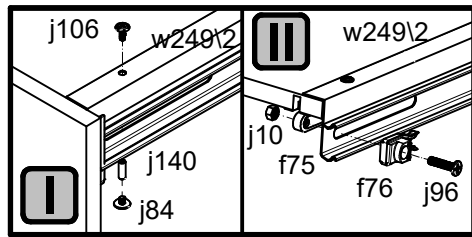
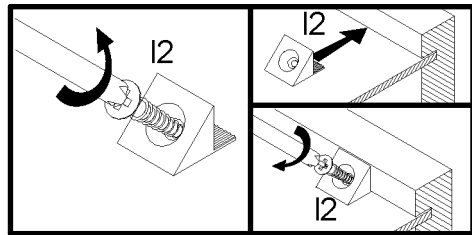
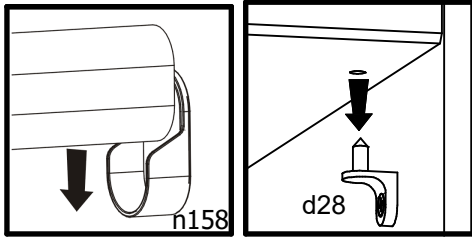
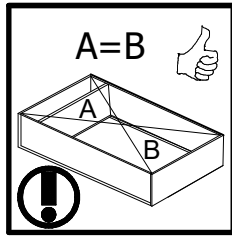

# 6

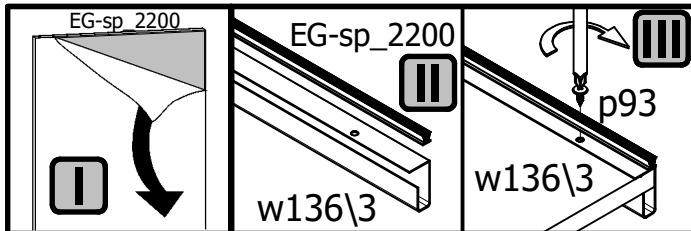
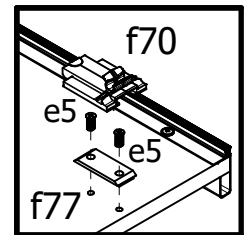
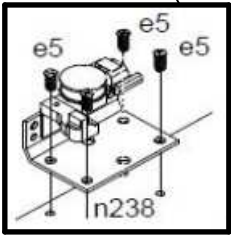
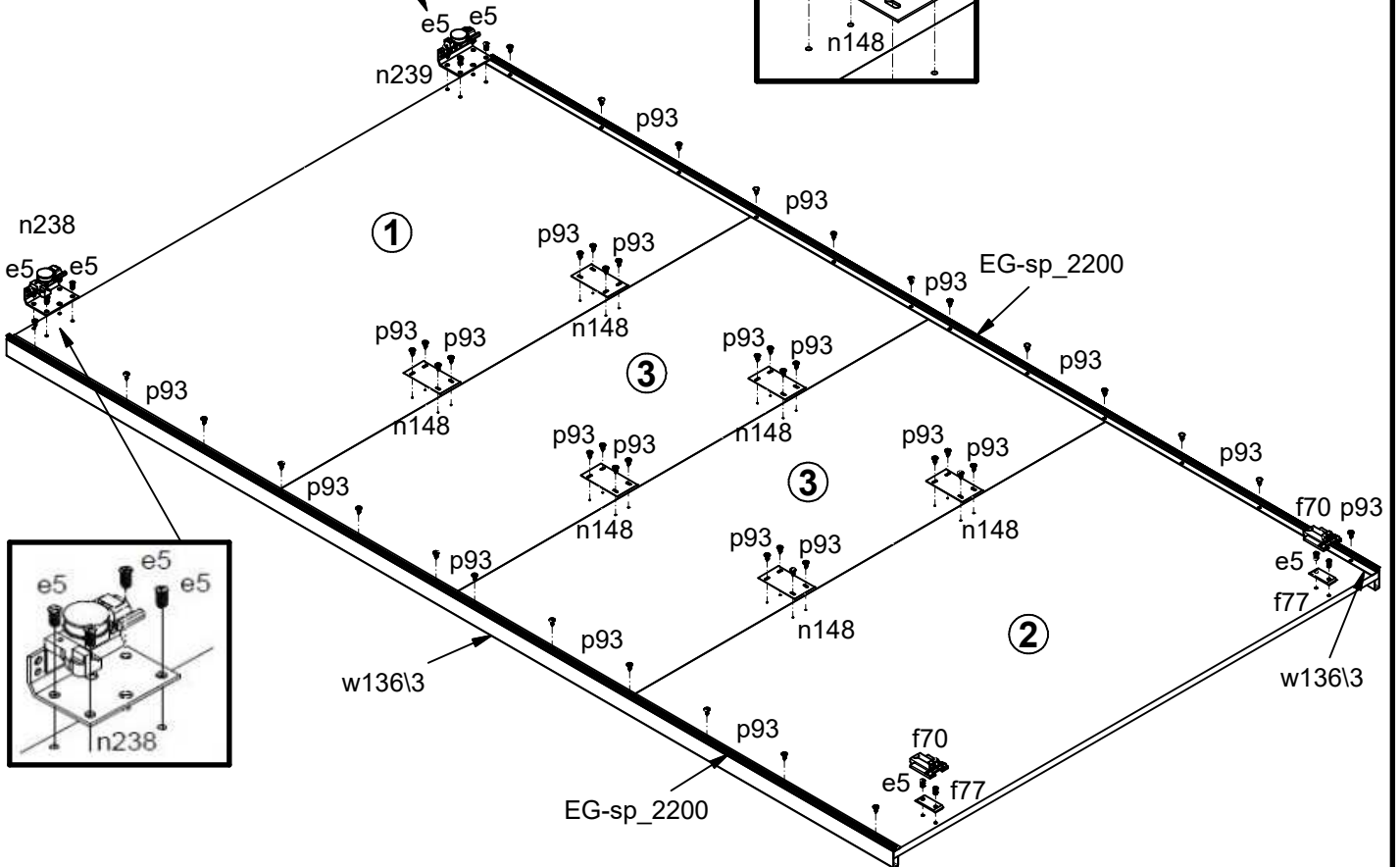
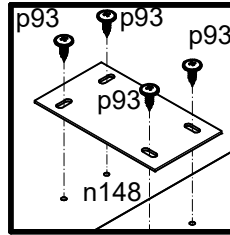
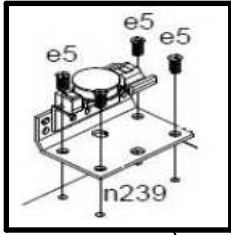
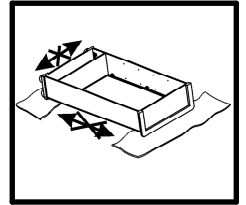

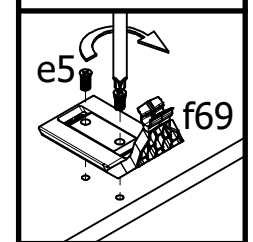
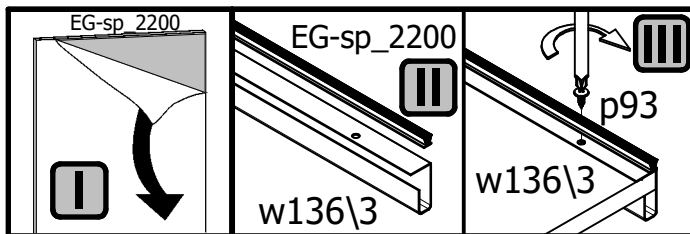
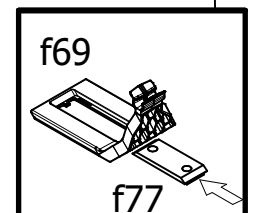
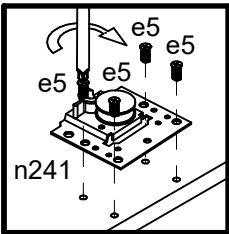
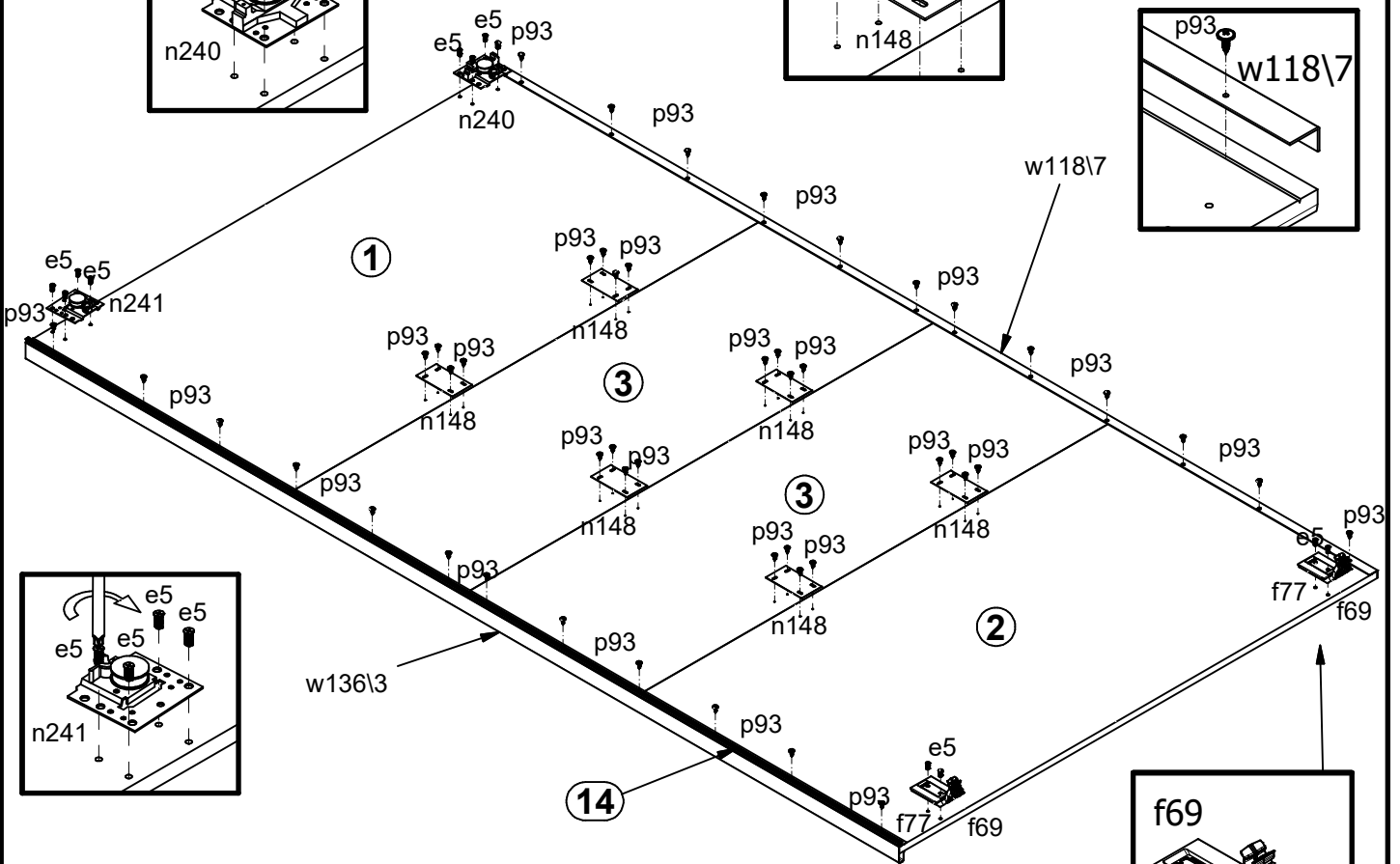
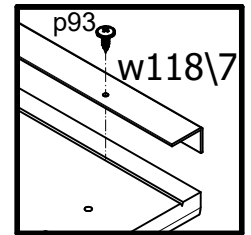
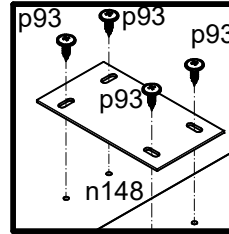
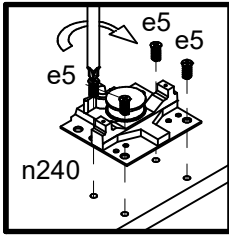
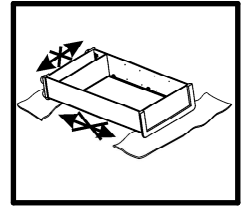

8 

