

A

S632-POL/135

LAMEA

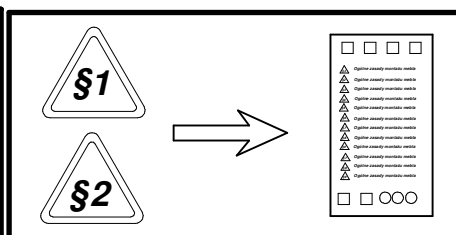

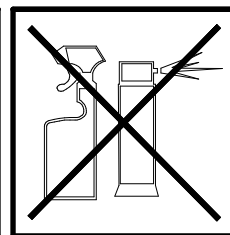
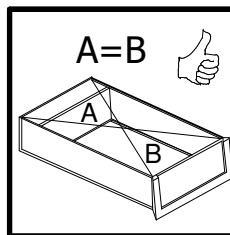
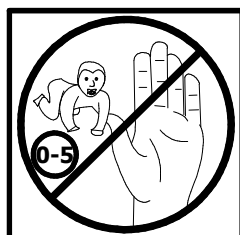
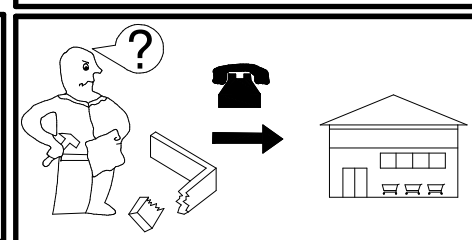
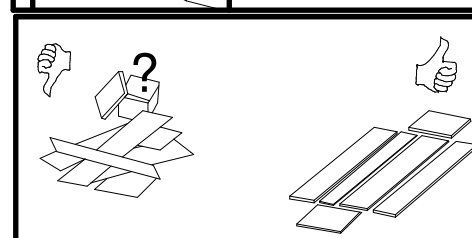
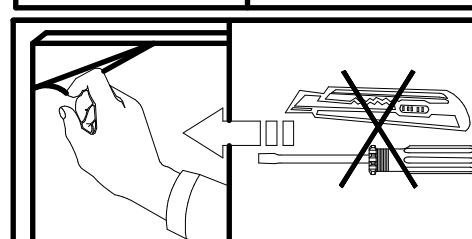
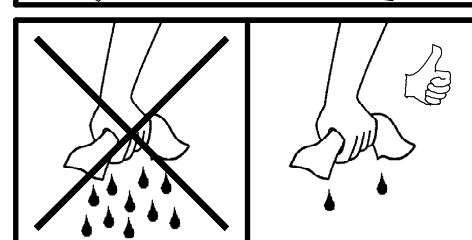
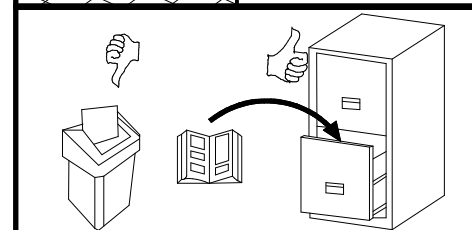
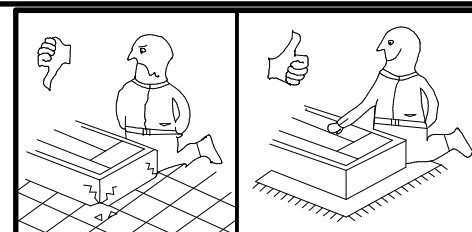
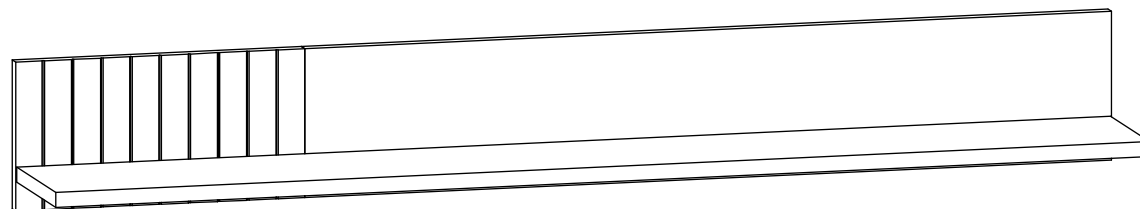
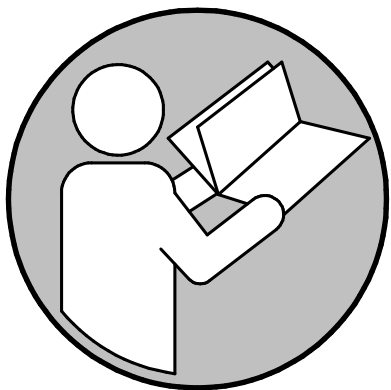
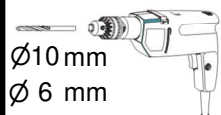
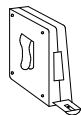
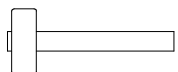
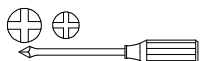
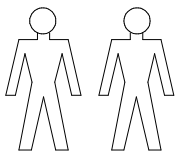

Ø10 mm
Ø 6 mm

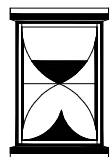

20 min

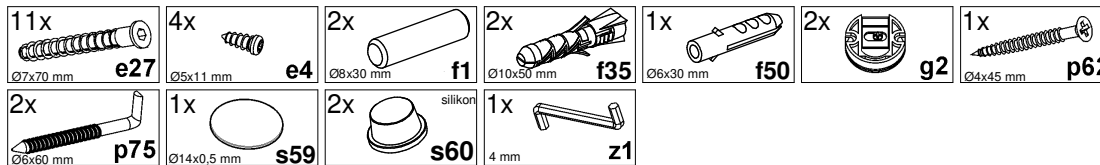



A	B1	B2	C1	C2	C3	D
1	S632-3014	-.2	1348	180	18	1/1
2	S632-4004	-.3	356	180	16	1/1
3	S632-4005	-.1	994	180	16	1/1

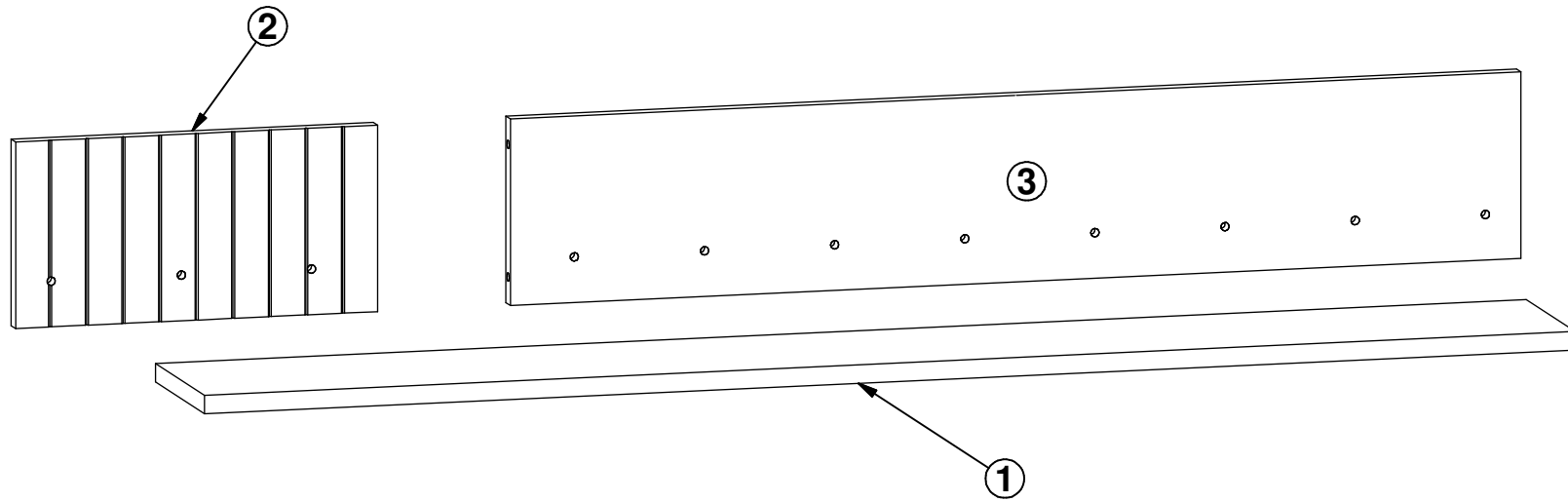

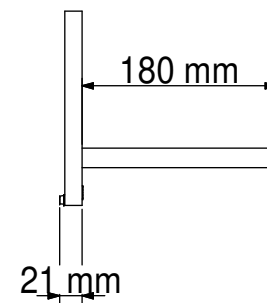
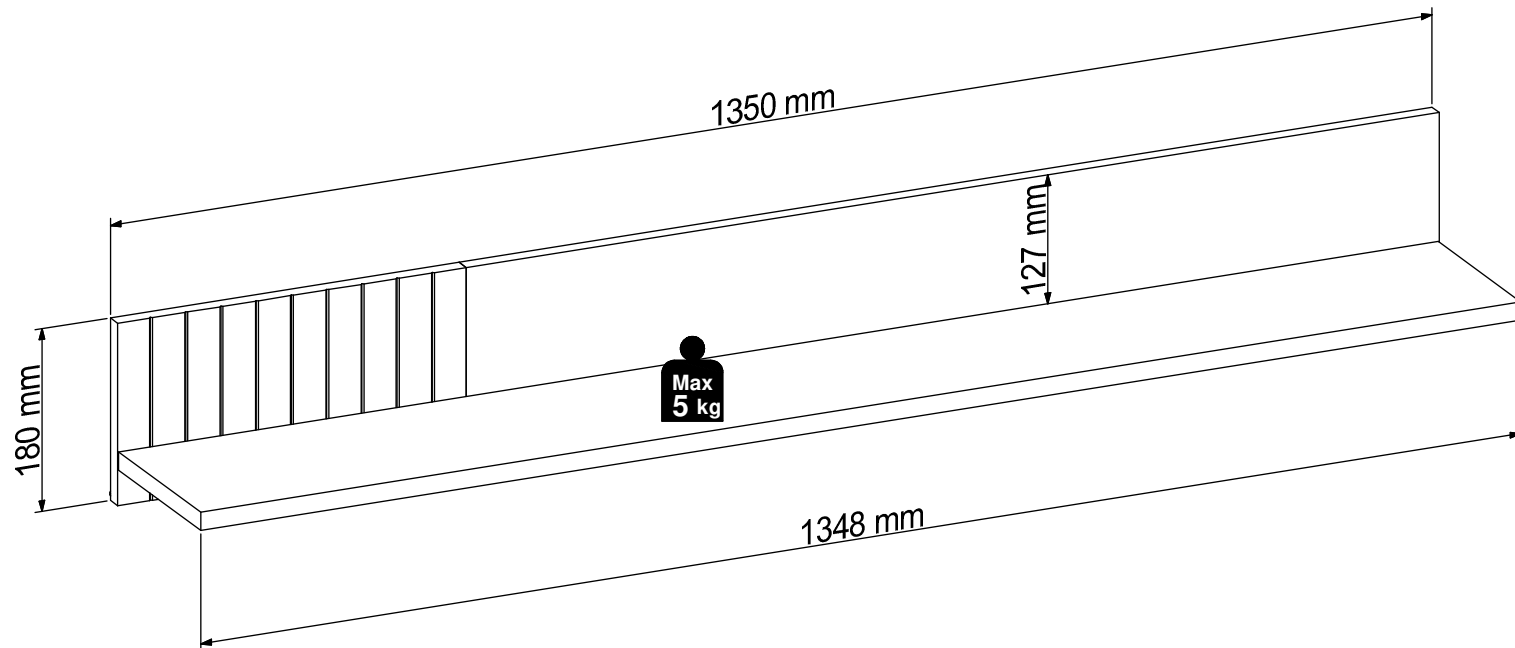



- 1 4x  e4
Ø5x11 mm
- 2x  f1
Ø8x30 mm
- 2x  g2

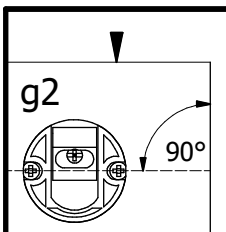
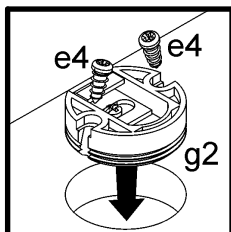
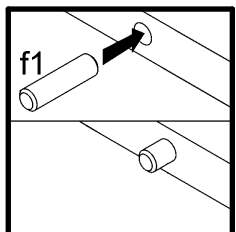
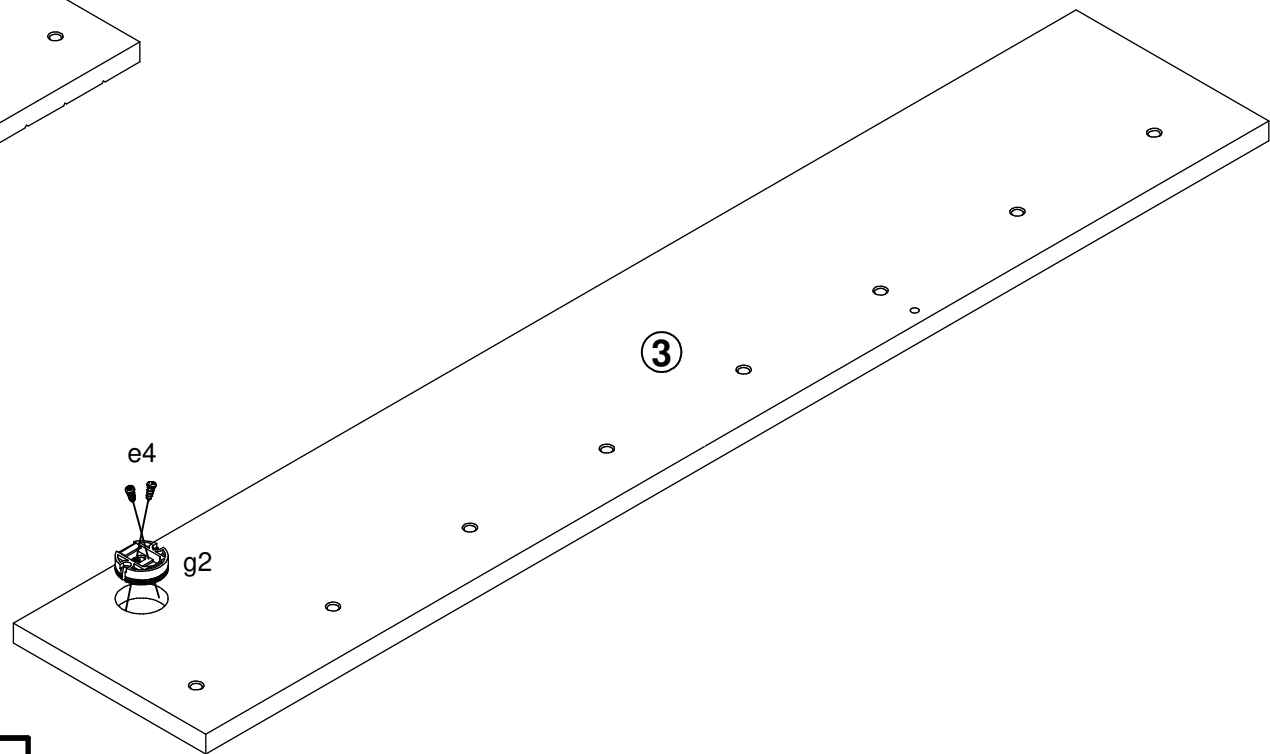
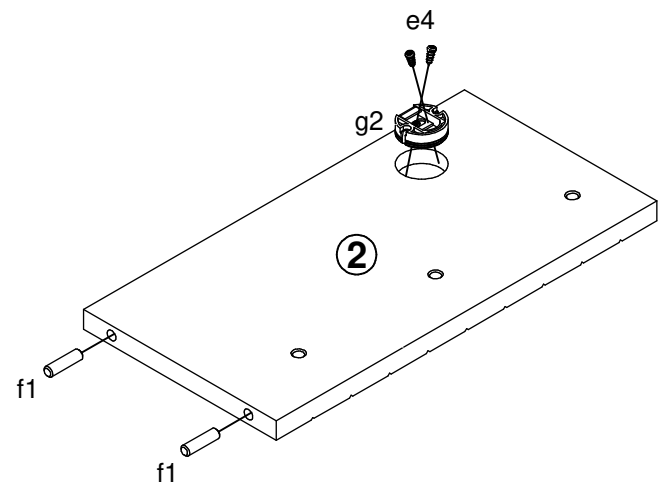

2

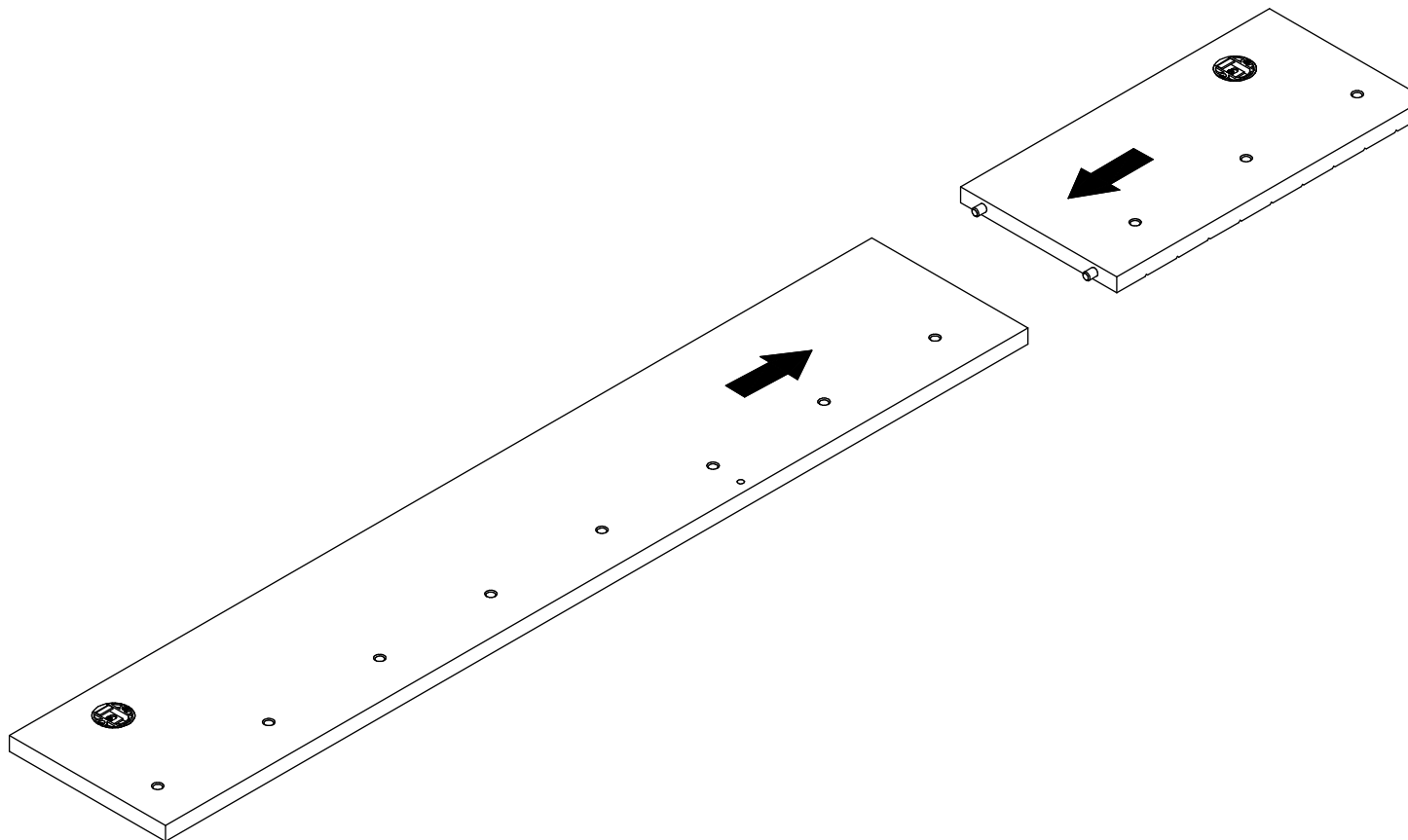

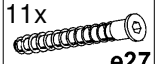
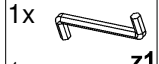
3 11x  e27 1x  z1 4 mm

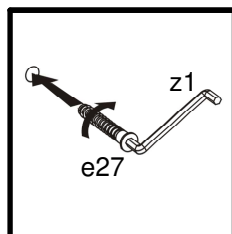
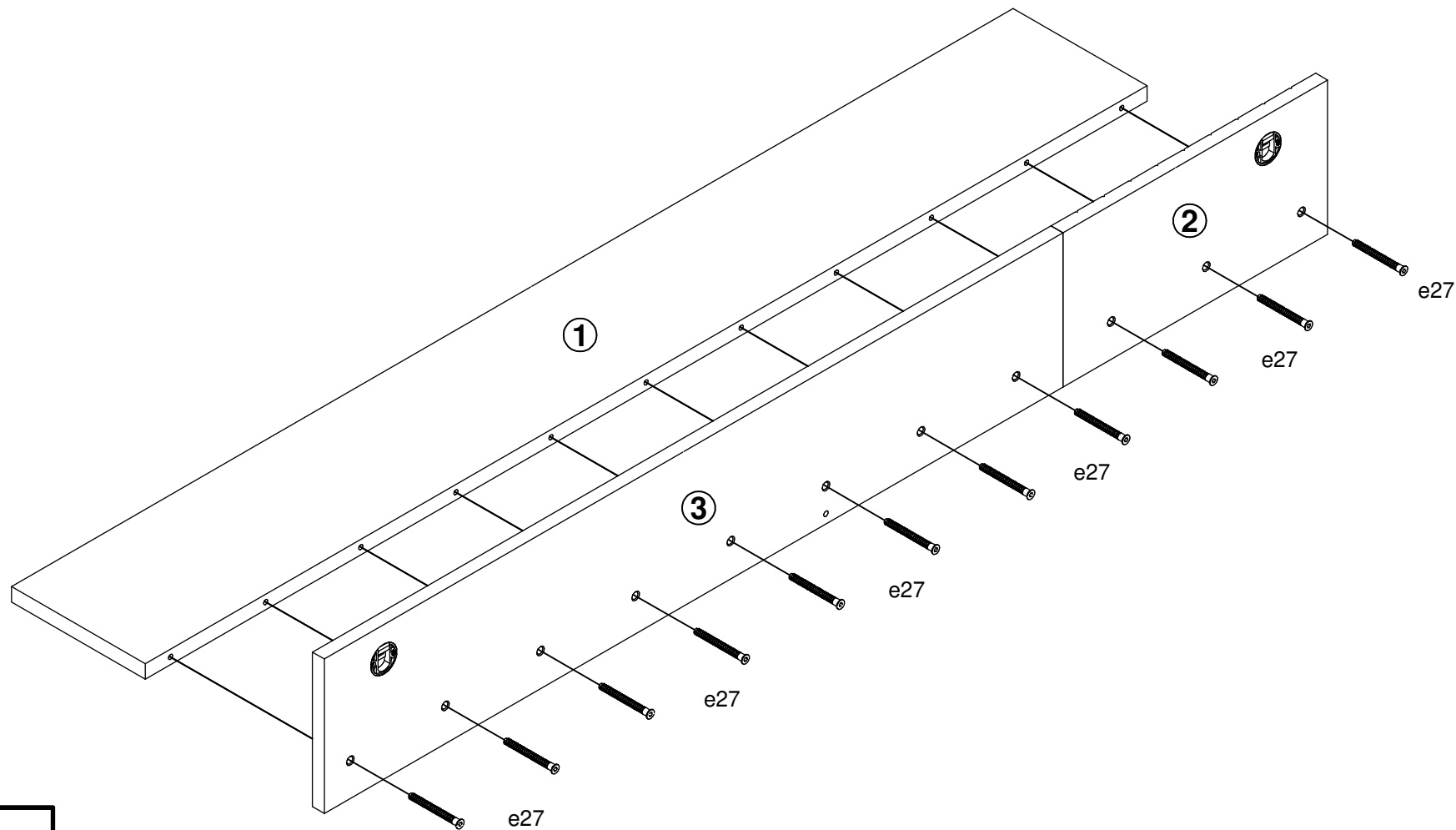

- 4 2x Ø10x50 mm f35
- 1x Ø6x30 mm f50
- 1x Ø4x45 mm p62
- 2x Ø6x80 mm p75
- 1x Ø14x0,5 mm s59
- 2x silikon s60

