

# NÁVOD NA MONTÁŽ KA-Y205

30 min



2 x



## ⚠️ 🇨🇪 MONTÁŽNÍ POKYNY

1. Pečlivě ověřte, zda díly před montáží nechybí nebo nejsou poškozené.
2. Při montáži dbejte pozor na přítomnost dětí, aby nedošlo k vdechnutí, spolknutí malých dílů nebo poranění.
3. **Šrouby během instalace neutahujte. Po instalaci všech šroubů je rovnoměrně utáhněte**

## POKYNY K POUŽÍVÁNÍ







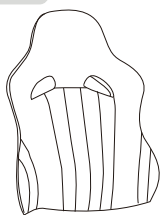

1. K čištění používejte pouze měkký hadřík, nečistěte ostrými nástroji.
2. Nepoužívejte na místech s nadměrným výskytem vlhkosti nebo teploty.
3. Při používání židle **nesedte** pouze v přední části nebo jen v její polovině.
4. Při použití funkce sklopení a houpání s opěradlem silně netřeste.
5. Nesedejte na židli v opačném směru, ani na ní **nestoupejte**.
6. Nesedejte na loketní opěrku ani za ní silně netahujte, může to být nebezpečné.
7. Nepoužívejte židli k jinému účelu, než je určena.

## ⚠️ 🇸🇰 MONTÁŽNE POKYNY

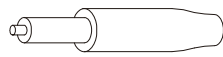
1. Starostlivo overte, či diely pred montážou nechybajú alebo nie sú poškodené.
2. Pri montáži dajte pozor na prítomnosť detí, aby nedošlo k vdýchnutiu, prehltnutiu malých dielov alebo poraneniu.
3. **Skrutky počas inštalácie neťahajte. Po inštalácii všetkých skrutiek ich rovnomerne utiahnite**

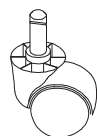
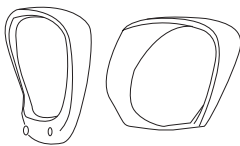
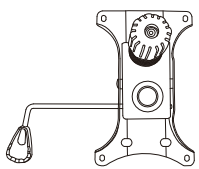
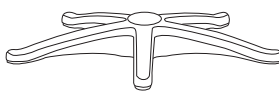
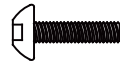
## POKYNY NA POUŽÍVANIE

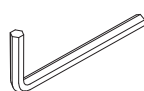
1. Na čistenie používajte iba mäkkú handričku, nečistite ostrými nástrojmi.
2. Nepoužívajte na miestach s nadmerným výskytom vlhkosti alebo teploty.
3. Pri používaní stoličky **nesedte** iba v prednej časti alebo len v jej polovici.
4. Pri použití funkcie sklopenie a hojdanie s operadlo silne netraste.
5. Nesadajte na stoličku v opačnom smere, ani na nej **nestúpajte**.
6. Nesadajte na lakťovú opierku ani za ňu silne nefahajte, môže to byť nebezpečné.
7. Nepoužívajte stoličku na iný účel, než je určená.

<b>A x 1</b> 	<b>B x 1</b> 	<b>C x 1</b> 	<b>D x 1</b> 	<b>E x 5</b> 
<b>F x 1L/1P</b> 	<b>G x 1</b> 	<b>H x 1</b> 	<b>I x 4</b>  M6 x 20	<b>2 x 4</b>  M6 x 25
<b>3 x 4</b> 	<b>4 x 1</b> 	<b>5 x 8</b> 	<b>6 x 4</b>  M6 x 35	



1

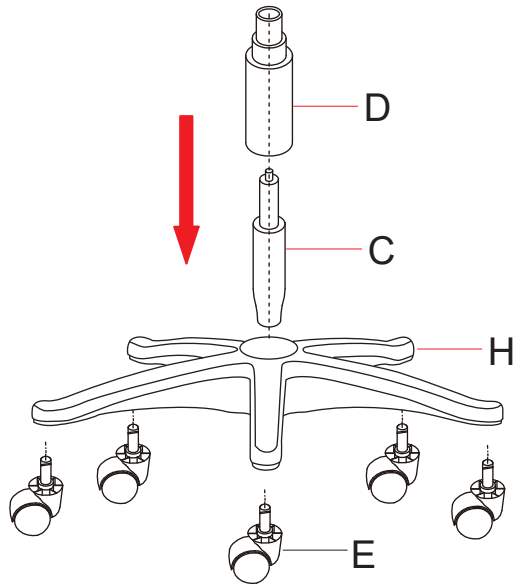
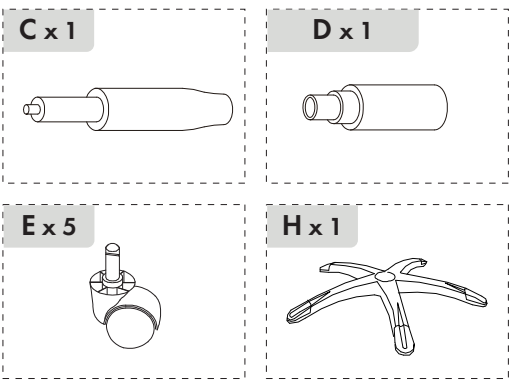

2

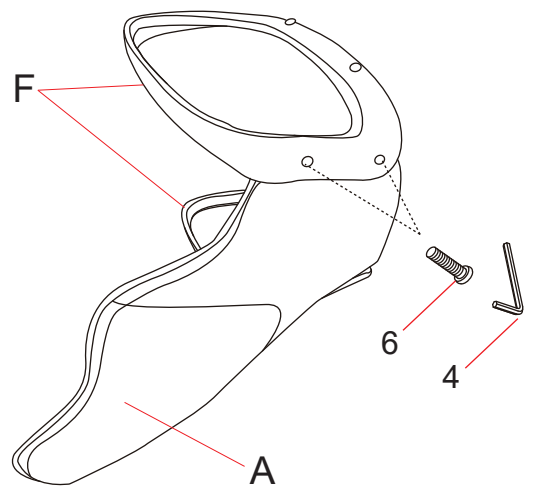
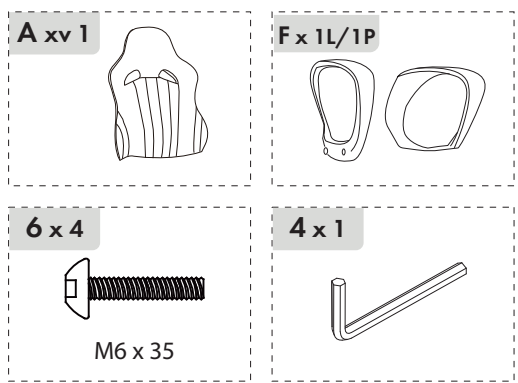

3

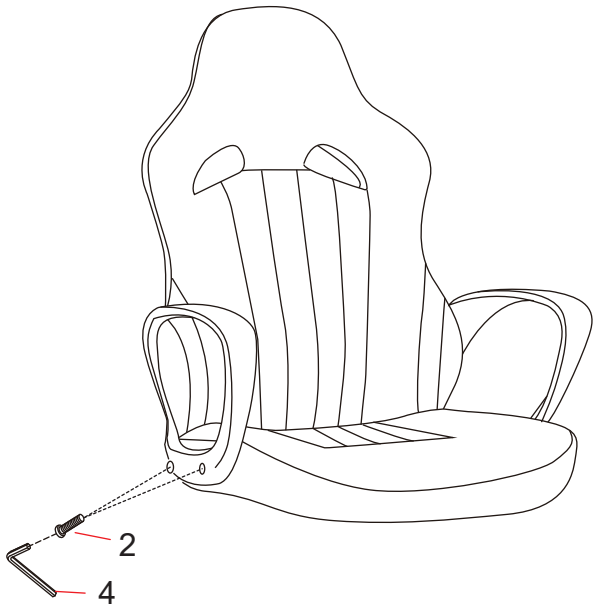
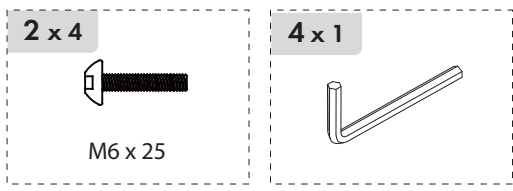

4

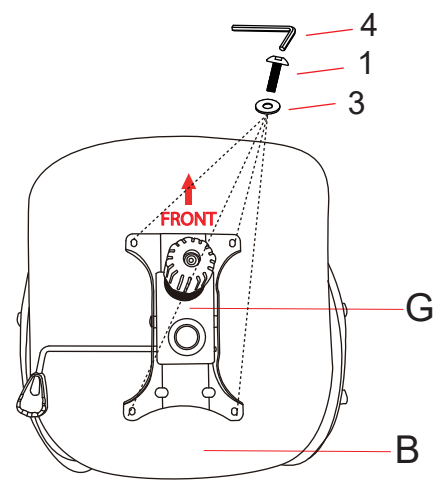
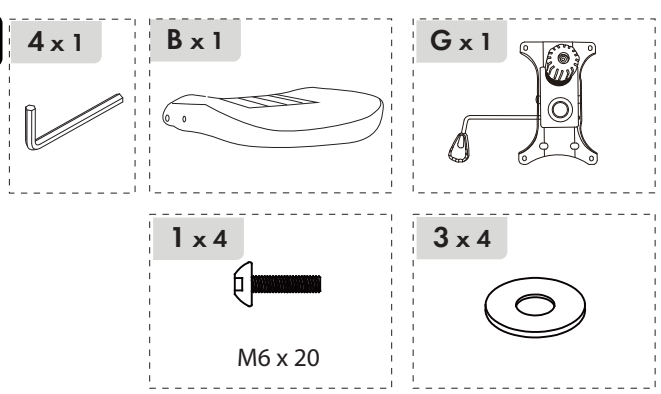

5

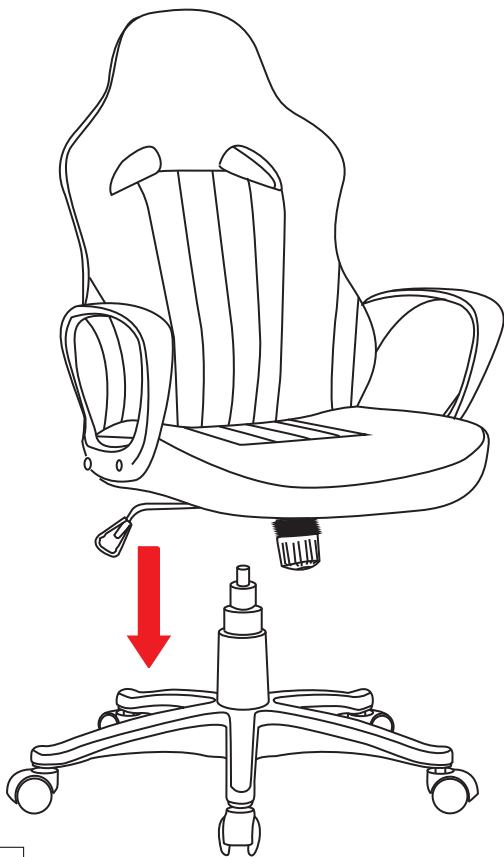

6

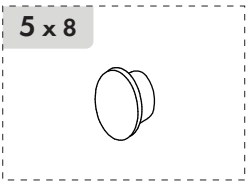

5



7

